

YAMAHA

CAR AUDIO

DIGITAL SOUND FIELD PROCESSOR

YDSP-1

OWNER'S MANUAL

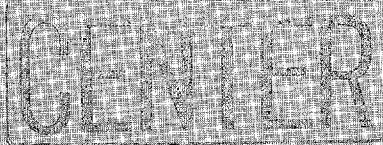

CONTENTS

SUPPLIED ACCESSORIES	2	USEFUL FUNCTIONS	22
FEATURES	3	TO ESCAPE THE "HELP!" MESSAGE OR	
PRECAUTIONS	3	DELETE ALL DATA YOU INPUT	25
DIGITAL SOUND FIELD PROCESSING	5	SELECTING DSP/EQ PROGRAMS	26
INSTALLATIONS	6	CREATING YOUR OWN SOUND FIELDS	31
CONNECTIONS	10	ADJUSTING EQUALIZER PARAMETERS	36
NECESSARY PROCEDURE SOON AFTER		STORING AN EDITED PROGRAM IN	
SETTING UP THE UNIT	12	THE USER MEMORY	37
IDENTIFICATION OF CONTROLS	13	DSP PROGRAM PARAMETER TABLE	39
ADJUSTMENTS BEFORE OPERATION	14	EQ PROGRAM PARAMETER TABLE	42
ENJOY SOUND WITH THE DSP/EQ		DIMENSIONS	43
EFFECT	18	TROUBLESHOOTING	44
SOUND OUTPUT LEVEL AND BALANCE		SPECIFICATIONS	45
ADJUSTMENTS	19		

SUPPLIED ACCESSORIES

- After unpacking, check that the following parts are contained.

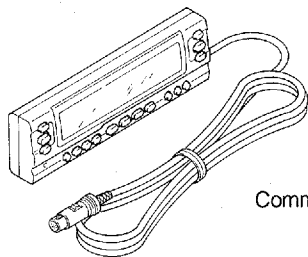

Commander unit

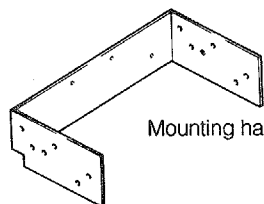

Mounting hardware

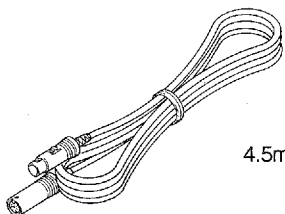

4.5m extension cable

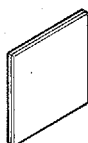

Magic fastener x2

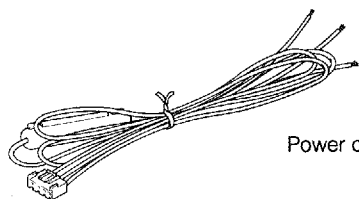

Power cords



5x16 tapping hex screw with washer x4



M2x5 screw x4



M5x8 screw x4

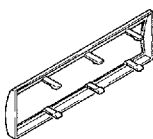

Frame



M5x8 hex screw with washer x4

FEATURES

- 8 preset DSP programs and 4 preset digital EQ programs
- Adjustable DSP/EQ parameters for creating your original programs
- 12 user programmable areas (8 for DSP and 4 for EQ)
- Selectable 3 acoustic modes for vehicle's interior
- Selectable 5 modes for speaker output and phase balance adjustment according to seating condition
- 9-band digital graphic equalizer (EQ)
- Separate configuration (main and control sections) for easy installation
- 2 extra subwoofer terminals
- Selectable high frequency (80/130Hz) cutoff points for subwoofer output
- Test tone generator for easier speaker output balance adjustment

PRECAUTIONS

■ CONNECTIONS

IMPORTANT! Improper connections and installation can damage the unit. Please read the installation instructions thoroughly before installing or connecting.

■ FUSES (2A rush resistant)

If a fuse has blown (no wire visible in the glass vial), first check if all connections are correct and the car's electrical system is operating properly. Replace ONLY with a fuse of the designated rating. If the fuse blows again, contact your nearest YAMAHA dealer or an authorized YAMAHA service center.

■ OPERATING TEMPERATURE

Extreme hot or cold indoor car temperature levels (parking in direct sunlight, snow, etc.) may result in malfunction. If this condition occurs, turn the unit off and allow the car's interior temperature to acclimate to a moderate level before use.

Note on temperature

To protect the display, the illumination becomes darker at high temperature. When the temperature lowers, the illumination becomes normal.

■ POWER INTERRUPTION

The unit has presets. This feature requires a constant power supply to retain their memories. If the car's power supply is interrupted for a long time (battery change, engine repair, etc.), the preset memories may be cleared. In this case, please reprogram them into memory as necessary.

■ NOISE INTERFERENCE

If the noise from another unit (Car receiver, Car tuner, etc.) is noticeable, change the location of this unit so that the noise is minimized.

ATTENTION

This sophisticated unit will enable the user to adjust various parameters of the soundfields and digital equalizer settings, allowing it to be tailored to the particular installation and owners taste. To prevent a traffic accident, THESE ADJUSTMENTS SHOULD ONLY BE PERFORMED WHILE THE VEHICLE IS STATIONARY. Once these setup adjustments have been completed, they may be stored in user memory for use while driving. Do not attempt altering any DSP settings while operating a moving vehicle.

WARNING

To prevent fire or shock hazard, do not expose this appliance to rain or moisture.

FCC INFORMATION (U.S.A.)

1. IMPORTANT NOTICE : DO NOT MODIFY THIS UNIT!

This product, when installed as indicated in the instructions contained in this manual, meets FCC requirements. Modifications not expressly approved by Yamaha may void your authority, granted by the FCC, to use the product.

2. IMPORTANT : When connecting this product to accessories and/or another product use only high quality shielded cables. Cable/s supplied with this product **MUST** be used. Follow all installation instructions. Failure to follow instructions could void your FCC authorization to use this product in the USA.

3. NOTE : This product has been tested and found to comply with the requirements listed in FCC Regulations, Part 15 for Class "B" digital devices. Compliance with these requirements provides a reasonable level of assurance that your use of this product in a residential environment will not result in harmful interference with other electronic devices.

This equipment generates/uses radio frequencies and, if not installed and used according to the instructions found in the users manual, may cause interference harmful to the operation of other electronic devices.

Compliance with FCC regulations does not guarantee that interference will not occur in all installations. If this product is found to be the source of interference, which can be determined by turning the unit "OFF" and "ON", please try to eliminate the problem by using one of the following measures:

Relocate either this product or the device that is being affected by the interference.

Utilize power outlets that are on different branch (circuit breaker or fuse) circuits or install AC line filter/s.

In the case of radio or TV interference, relocate/reorient the antenna. If the antenna lead-in is 300 ohm ribbon lead, change the lead-in to co-axial type cable.

If these corrective measures do not produce satisfactory results, please contact the local retailer authorized to distribute this type of product. If you can not locate the appropriate retailer, please contact Yamaha Electronics Corp., U.S.A. 6722 Orangethorpe Ave, Buena Park, CA 90620.

The above statements apply **ONLY** to those products distributed by Yamaha Corporation of America or its subsidiaries.

WARNING: CHEMICAL CONTENT NOTICE!

The solder used in the manufacture of this product contains LEAD. In addition, the electrical/electronic and/or plastic (where applicable) components may also contain traces of chemicals found by the California Health and Welfare Agency (and possibly other entities) to cause cancer and/or birth defects or other reproductive harm.

DO NOT REMOVE ANY ENCLOSURE COMPONENTS!

There are no user serviceable parts inside. All service should be performed by a service representative authorized by Yamaha to perform such service.

IMPORTANT MESSAGE: Yamaha strives to produce products that are both user safe and environmentally "friendly". We sincerely believe that our products meet these goals. However, in keeping with both the spirit and the letter of various statutes we have included the preceding messages and others in various locations in this manual.

DIGITAL SOUND FIELD PROCESSING

What is it that makes live music so good? Today's advanced sound reproduction technology lets you get extremely close to the sound of a live performance, but chances are you'll still notice something missing, the acoustic environment of the live concert hall. Extensive research into the exact nature of the sonic reflections that create the ambience of a large hall has made it possible for Yamaha engineers to bring you this same sound in your own listening room, so you'll feel all the sound of a live concert. What's more, our technicians, armed with sophisticated measuring equipment, have even made it possible to capture the acoustics of a variety of actual concert halls, jazz clubs, theaters, etc. from around the world, to allow you to accurately recreate one of a large variety of actual live performance environments, all in your own listening space.

The basic theory and principles governing car-use DSP are the same as those that underlie home audio use DSP. However, a different operational process is necessary to achieve an effective sound field in the car environment. Employing a new kind of processing system, this unit derive an impressive audio performance for in-car listening while creating a sound field effect with superb presence and depth.

SETTING UP YOUR SPEAKER SYSTEM

You can enjoy various excellent acoustic environments by using the conventional 4-speaker system that currently forms the main trend among car audio enthusiasts, thus eliminating the need to install special effect speakers.

Front speakers and rear speakers are both used for reproducing source (main) sound and effect sound (to characterize sound reflections, reverberations, etc.). As for the concept of the DSP for home use, the rear speakers are for effect sound only. However, for car audio use, we considered that the rear speakers should be used for reproducing both source (main) and effect sounds. The reason for this idea is that, though source (main) sound must be reproduced through a higher graded speaker system to maintain the whole sound quality, as the main trend of four speaker system setting up for car audio, the higher graded speaker system is usually used for the rear speakers (not for the front speakers). In addition, this unit is designed to allow you to select whether to reproduce source (main) sound through the rear speakers or not. Furthermore, you can adjust the mixing rate of source (main) sound with effect sound at the rear speaker at will.

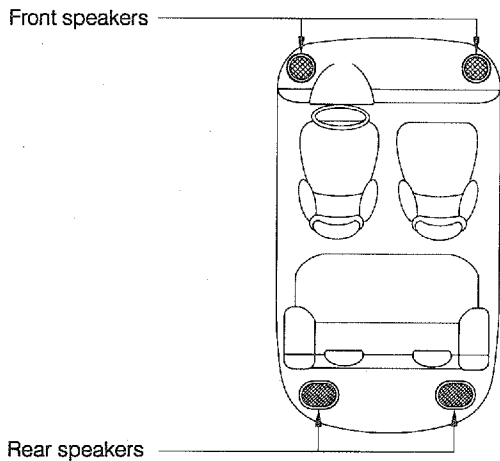

INSTALLATION

This unit consists of a main unit and a commander unit. Both of the units need to be installed on the proper locations. Refer to the following instructions on their installation.

HOW TO INSTALL THE MAIN UNIT

Before Installation

1. Be sure to remove the ground cable from the negative (-) terminal of the car battery to prevent accidental short-circuit during installation.
2. Check whether the provided mounting screws are complete.
3. Avoid the locations shown below:
 - Locations which can be subject to splashes of water, such as on the car floor in the vicinity of a door.
 - Locations in the driver's legroom area which can pose a hazard to driving safety.
 - Locations subject to hot air flow such as in the vicinity of heating outlets.
 - Locations which obstruct heat dissipation of the unit, such as in the glove compartment or under a floor mat, etc.
 - Locations which are close to the car's antenna.
 - If an electronic ignition fuel injection or other microprocessor control unit is located inside the car, mount the unit as far away as possible to avoid interference.
4. Use the provided mounting screws and install the unit, referring to the illustration.
5. If work on the car body, such as drilling holes etc., is necessary, consult your dealer.
6. When installing the unit under a seat, make sure that it does not touch any part of the seat.
7. In car models where the antenna is mounted in the trunk, the unit should not be mounted inside the trunk.

Install the unit under a seat or in the trunk by using the provided 5x16 tapping hex screws observing the above.

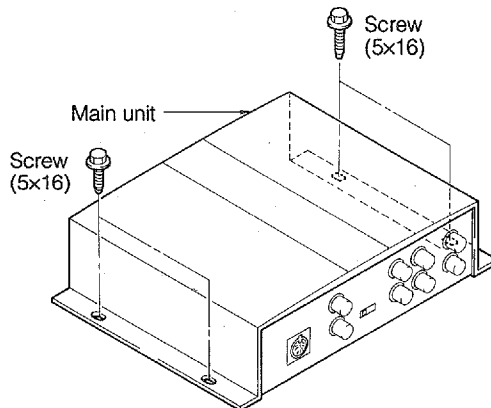

HOW TO INSTALL THE COMMANDER UNIT

Before Installation

1. Do not install the unit where it will be exposed to extreme temperatures, such as near the car heater, air conditioner or in direct sunlight. Mount the unit where it will not interfere with your driving nor be subject to excessive vibration and dust.
2. There are two ways, **A** and **B**, to install the commander unit as shown below.
3. Read the CAUTION LABEL attached on the commander unit to select the proper installation position.

A Installation by Attaching the Unit to the Dashboard

1.

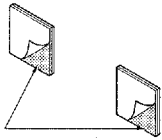

Adhesive surface appears.

Detach the sheets from the magic fasteners on one side.

2.

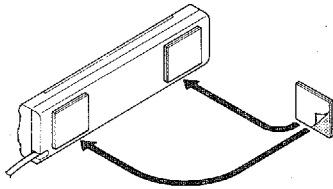

Attach the adhesive surface to the back of the unit.

3.

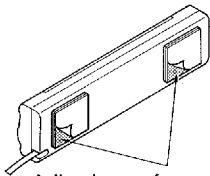

Adhesive surface appears.

Separate the sheets from the other side of the magic fasteners.

4.

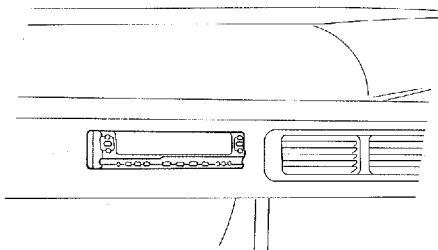

Attach the unit onto the proper position of the dashboard.

* Refer to the CAUTION LABEL for proper installation position.

B Installation by Inserting the Unit into the DIN-sized Hollowed Space of the Dashboard

Notes

- Check whether the installation position has sufficient dimensions: width, depth, and height.
- Use the provided mounting hardware and install the unit, referring to the illustration. If work on the car body, such as drilling holes etc., is necessary, consult your dealer.

1. Fix the commander unit to the mounting hardware by using the provided screws (M2x5).

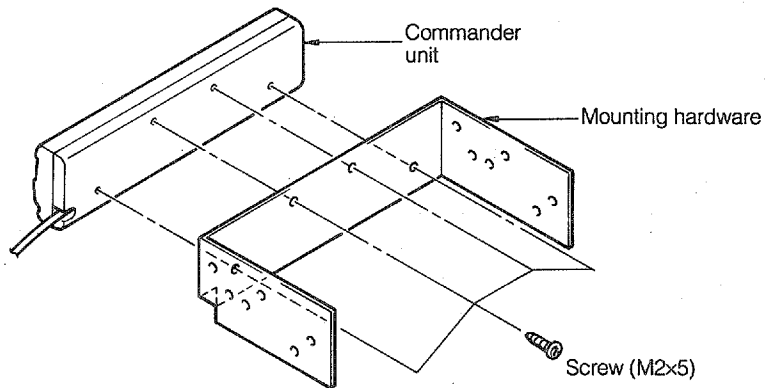

2. Insert the component made in the step 1 into the selected hollowed space of the dashboard.

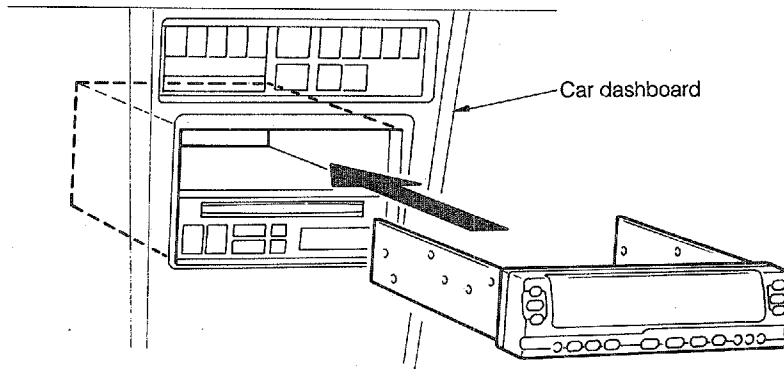

3. Secure the component by using at least 4 screws (M5x8).

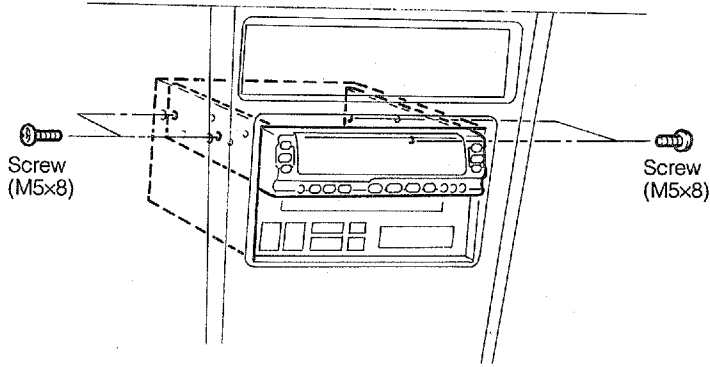

4. Attach the frame and secure the unit to the dashboard.

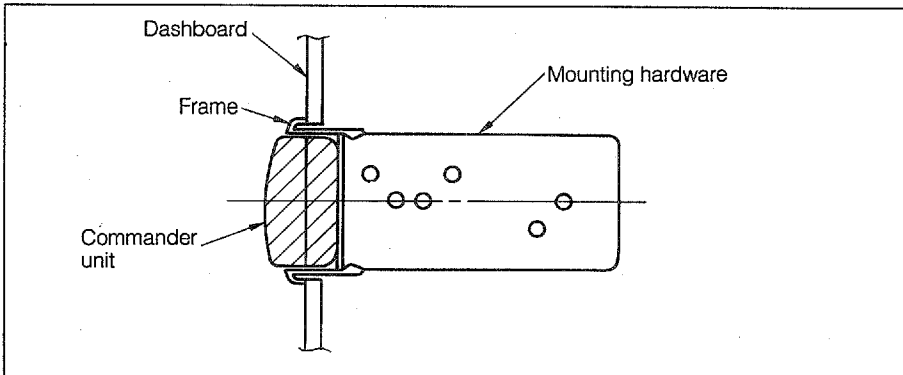
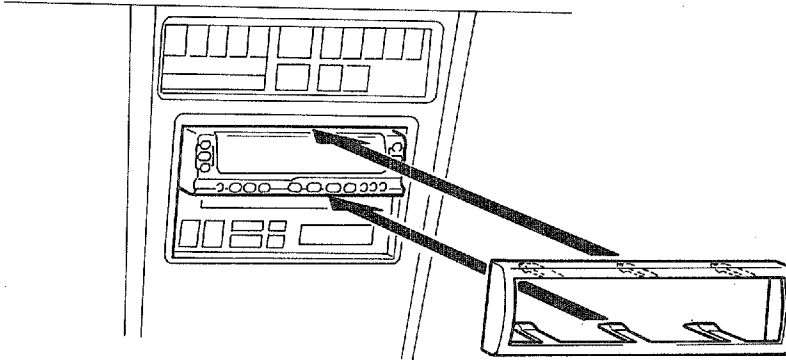

CONNECTIONS

For Secure and Safe Connections

1. Before making any connection, be sure to remove the ground cable from the negative (-) terminal of the car battery, to prevent accidental short-circuiting during connections.
2. After completing all connections, check once more for correctness, re-install all parts of the car in their original position, and then reconnect the negative (-) terminal of the car battery.
3. After checking all connections, initialize the unit. (Refer to the page 12.)

CONNECTION TO EACH COMPONENT

When making connections between this unit and other components, be sure all connections are made correctly, that is to say L (left) to L (right) to R (right) to R. Also, refer to the owner's manual for each component to be connected to this unit.

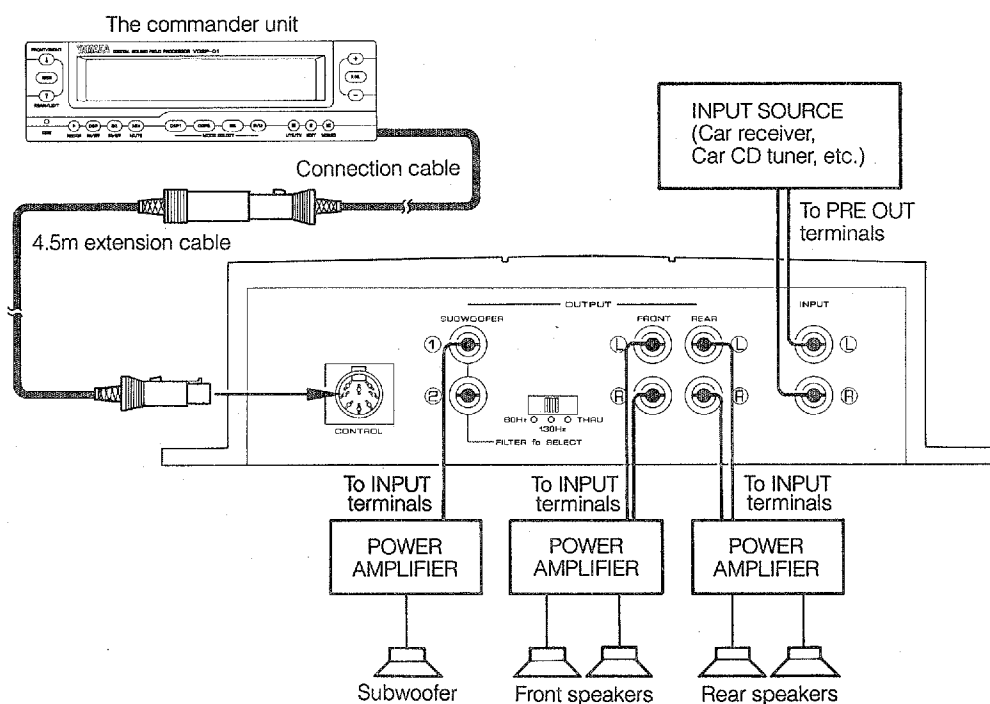

Notes

- If the provided connection cable between the commander unit and the main unit is too short in your installation, use the provided 4.5m extension cable.
- This unit provides two monaural output terminals for subwoofers, so allowing you to connect two power amplifiers for driving subwoofers.

To obtain the best performance of this unit, adjust the sound output control of the input source as shown below.

Set the sound output control of the input source to about the half way position between the middle and max. level. However, decrease the level if the sound is distorted, or increase the level if the sound is output with noise.

* If you use YAMAHA YCDT-720, set its sound output level to the max. and then, press the volume control (-) button four times.

SUBWOOFER SWITCH

By using this switch, you can adjust the bass range to be output from the subwoofer output terminals to the subwoofer amplifier.

- **80Hz**
Selecting this position sets the cutoff frequency of the subwoofer at 80Hz.
The subwoofer output terminal outputs low-frequency sound of 80Hz and below.
- **130Hz**
Selecting this position sets the cutoff frequency of the subwoofer at 130Hz.
The subwoofer output terminal outputs low-frequency sound of 130Hz and below.
- **THRU**
The subwoofer output terminal outputs a full-range frequency sound.

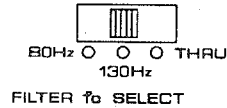

CONNECTION TO CAR BATTERY

Refer to the diagram for proper connections. Be sure to make good, well insulated connections.

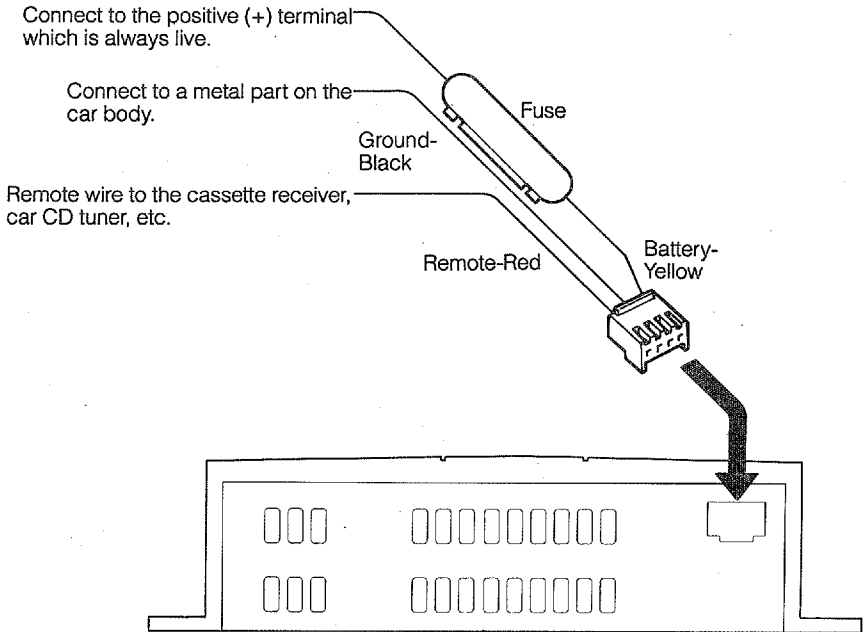

NECESSARY PROCEDURE SOON AFTER SETTING UP THE UNIT

After the installation and connection, initialize the unit as shown below.

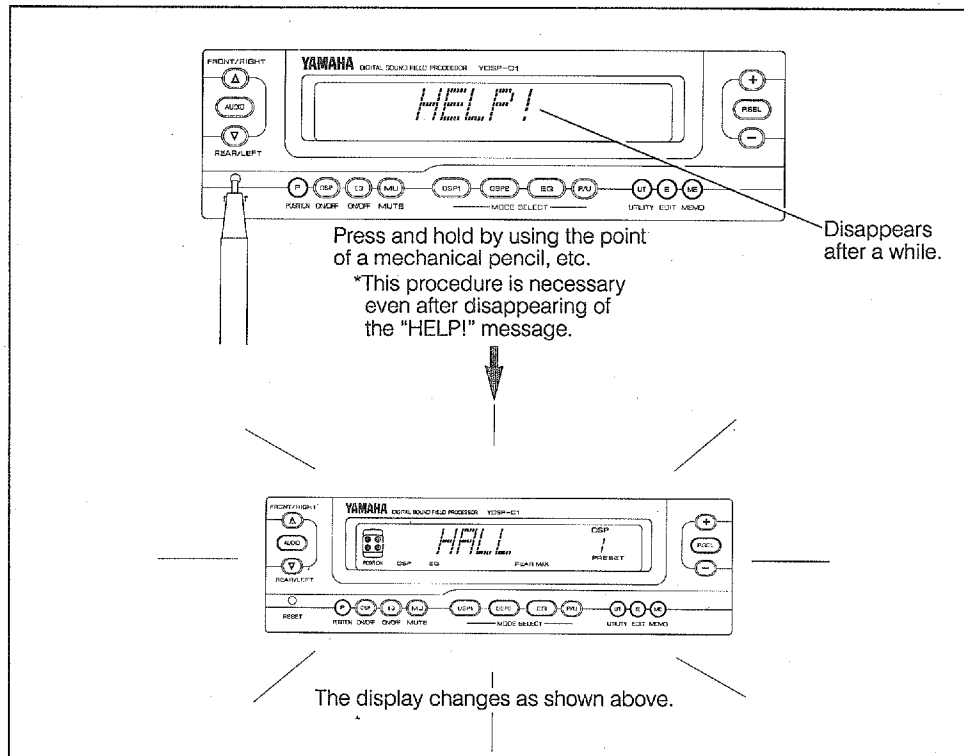

Note

For other functions of initializing, refer to the page 25.

IDENTIFICATION OF CONTROLS

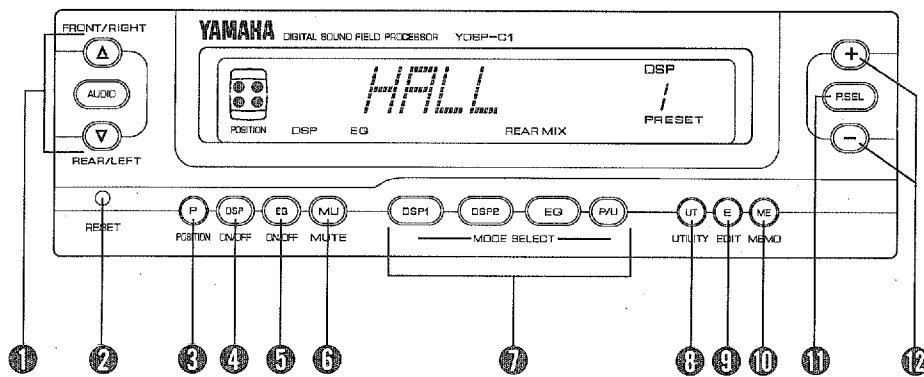

- 1 AUDIO**
Used for sound output level and balance adjustment. (See pages 19-21.)
- 2 RESET**
Initializes the unit. (See pages 12 and 25.)
- 3 POSITION**
Selects speaker output and phase balance modes suitable for the seating condition. (See page 17.)
- 4 DSP ON/OFF**
Switches the digital sound field processor (DSP) on/off. (See page 26.)
- 5 EQ ON/OFF**
Switches the digital graphic equalizer (EQ) on/off. (See page 26.)
- 6 MUTE**
Mutes the sound output level by 20dB. (See page 25.)
- 7 DSP - EQ MODE SELECT**
Select DSP/EQ programs or user program-able areas. (See pages 26-30, 37.)
- 8 UTILITY**
Selects four types of useful functions to derive the best performance from this unit.

 - Adjustment of the main sound mixing level at rear speakers (See page 22.)
 - Switching (on/off) of the main sound mixing at rear speakers. (See page 23.)
 - Test tone generator (See pages 14 and 15.)
 - Selection of acoustic modes suitable for the vehicle's interior (See page 16.)
- 9 EDIT**
Selects three types of editing mode.

 - Adjustment of effect sound level (See page 24.)
 - Adjustment of DSP parameters (See page 32.)
 - Adjustment of EQ parameter (See page 36.)
- 10 MEMO (MEMORY)**
Used to store user's original programs. (See pages 37 and 38.)
- 11 P.SEL**
Selects DSP/EQ parameters. (See pages 32 and 36.)
- 12 +/-**
Used to change values for various adjustments.

ADJUSTMENTS BEFORE OPERATION

PREPARATION TO GAIN THE BEST CONDITION OF SPEAKER OUTPUT BALANCE

Using the built-in test tone generator, this procedure lets you adjust the sound output balance to the best condition between the front, rear, left and right speakers. This is important for the best performance of this unit.

Once performed, this adjustment will not be necessary. However, if you change any of the connected components, speaker position, or your car itself, this adjustment should be performed again.

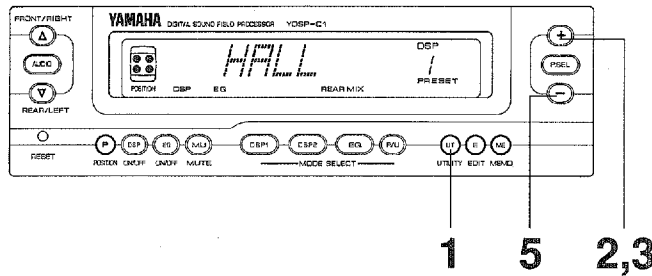

1 Set the display as shown below.

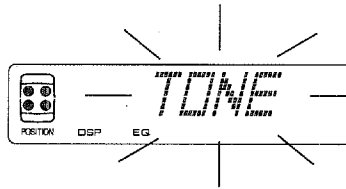

2 Start the test **TONE**. You will hear a test **TONE** sound from the left front speaker, then the right front speaker, then the right rear speaker, then the left rear speaker and finally from all the speakers simultaneously.

* When the test **TONE** sound output level is too high or low, first adjust the sound output level. (Refer to the page 19 on how to adjust.) Then, return to the step 1 and start again.

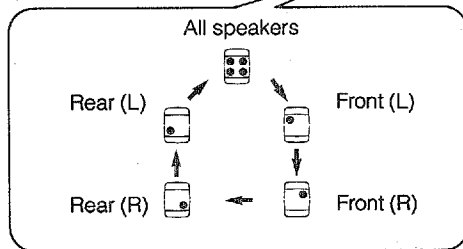

The indicator changes as shown above.

- 3** While the test **TONE** is being output from each speaker in turn, select the speaker to be adjusted.

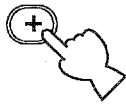

The indicator for the selected speaker flashes on and off continuously.
At the same time, the test **TONE** comes to be output only through the selected speaker.

- 4** By adjusting the INPUT LEVEL control of the power amplifiers, make the test **TONE** from each selected speaker the same level.

* The position where you perform this procedure should be in the center of the car room.

- 5** Stop the test **TONE**.

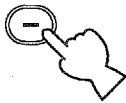

The display before these procedures will be again re-displayed.

Notes

- In the step 3, instead of selecting each speaker mode in turn, selecting all speakers mode at the same time may make the next adjustment easier.
- In the most cases, you will use two power amplifiers; one for the front speakers, and another for the rear speakers. If you adopt this configuration, the left and right speakers should be in a pair. Because, in this configuration, it may not be possible to adjust the left-right balance of the sound output level.
- If one of your power amplifiers can adjust its input level and another one can not, the step 4 procedure should be performed only by adjusting the adjustable one.

PREPARATION TO MATCH THE SOUND FIELD TO YOUR CAR

You can match the sound field to the acoustics of your vehicle's interior or speaker installation condition. Once performed, this adjustment will not be necessary. However, if you change any of speaker units, speaker positions, or your car itself, this adjustment should be performed again.

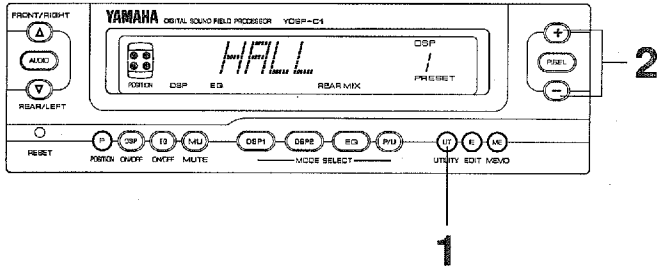

1 Set the display as shown below.

2 Select the type suitable for your car.

The indicator changes as shown above.

TYPE-A Car with front speakers in the dash board.
 TYPE-B Car with front speakers in the doors.
 TYPE-C Van type vehicle.

MATCHING THE VOLUME AND PHASE BALANCE SETTING TO THE SEATING CONDITIONS

You can match the volume and phase balance setting only by selecting a current seating condition to obtain the best possible performance. Note that "PREPARATION TO GAIN THE BEST CONDITION OF SPEAKER OUTPUT BALANCE" and "PREPARATION TO MATCH THE SOUND FIELD TO YOUR CAR" are necessary before this procedure.

This adjustment should be performed when the seating conditions are changed. At that time, you do not have to stop the input source sound.

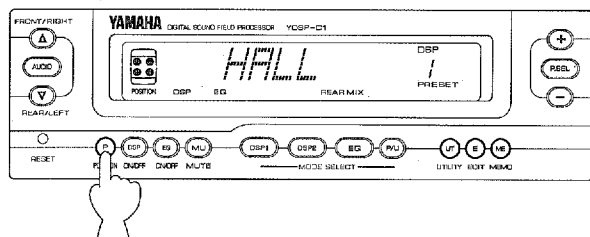

Select the desired position.

Flashes on and off continuously.

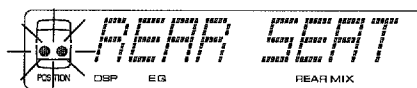
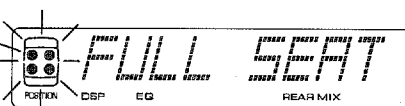

About 10 seconds after selecting the position, when the display before these procedures is again re-displayed, the setting is completed.

Flashes on and off continuously for a while.

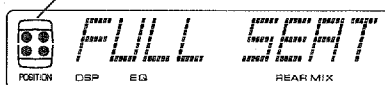

ENJOY SOUND WITH THE DSP/EQ EFFECT

You can enjoy the sound of the input source with the DSP and/or EQ effect after performing "ADJUSTMENTS BEFORE OPERATION" procedures. Now, only you have to do is select your favorite program and adjust the sound output level.

For details on the DSP/EQ programs, refer to the corresponding pages.

To select DSP and/or EQ programs

Refer to the pages 26 and 27.

Features of each program

Refer to the pages 28-30.

Furthermore, if you plan to realize the sound field closer to your ideal, refer to the corresponding part in "USEFUL FUNCTIONS" and "CREATING YOUR OWN SOUND FIELDS".

To create your own DSP and/or EQ programs

Refer to the pages 31-36.

To store your own programs

Refer to the pages 37 and 38.

SOUND OUTPUT LEVEL AND BALANCE ADJUSTMENTS

SOUND OUTPUT LEVEL ADJUSTMENT

You can adjust the sound output level at all speakers: front, rear speakers and subwoofer.

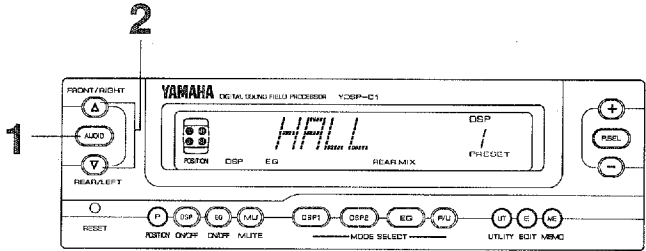

1 Set the display as shown below.

2 Adjust the sound output level.

To increase the level.

To decrease the level.

Changes on each press.
(Changeable range: 0 — 76)
(At minimum: ---)

- Notes**
- About 10 seconds later, the display before these procedures will be again re-displayed.
 - Only following the step 2 can also adjust the sound output level except when the unit is showing the "BAL" or "FAD" on the display.

Note on pressing the AUDIO button

Note that the display changes as shown below when you press the **AUDIO** button repeatedly.

..... Refer to the page 20 for details.

..... Refer to the page 21 for details.

RIGHT-LEFT BALANCE ADJUSTMENT OF SOUND OUTPUT

By using this adjustment, you will be able to compensate for sound imbalance caused by speaker settings or listening conditions.

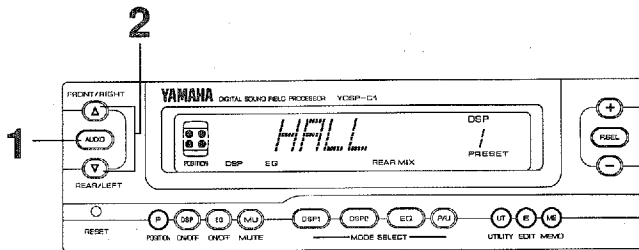

1 Set the display as shown below.

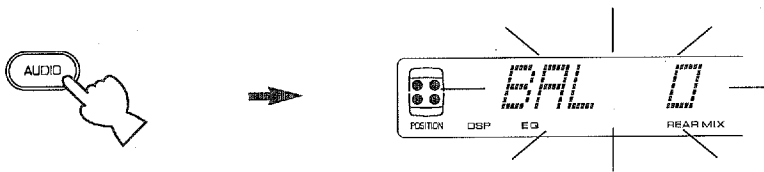

2 Adjust the right and left balance.

To raise the sound output proportion at the right and lower the sound output proportion at the left.

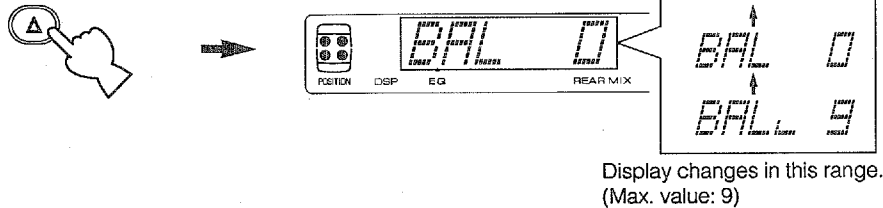

To raise the sound output proportion at the left and lower the sound output proportion at the right.

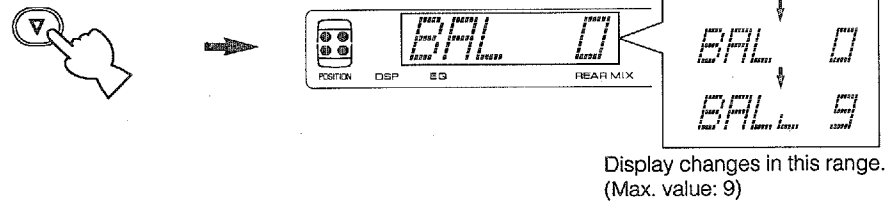

Note

About 10 seconds later, the display before these procedures will be again re-displayed.

FRONT-REAR BALANCE ADJUSTMENT OF SOUND OUTPUT

By using this adjustment, you will be able to compensate for sound imbalance caused by speaker settings or listening conditions.

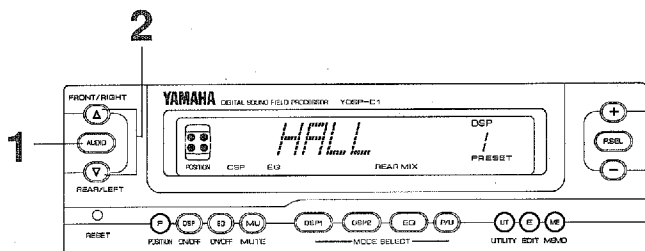

1 Set the display as shown below.

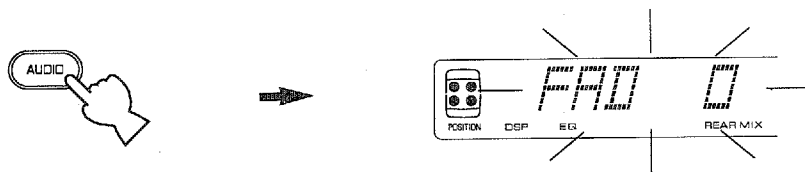

2 Adjust the front and rear balance.

To raise the sound output proportion at the front and lower the sound output proportion at the rear.

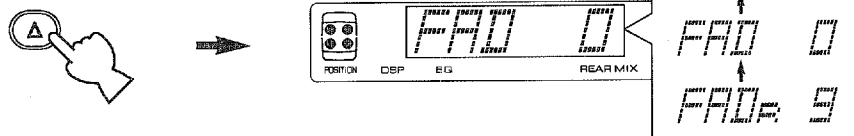

Display changes in this range.
(Max. value: 9)

To raise the sound output proportion at the rear and lower the sound output proportion at the front.

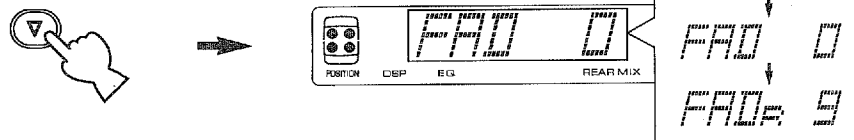

Display changes in this range.
(Max. value: 9)

Note

About 10 seconds later, the display before these procedures will be again re-displayed.

USEFUL FUNCTIONS

ADJUSTING THE MIXING LEVEL OF THE MAIN SOUND WITH THE EFFECT SOUND ON THE REAR SPEAKERS

Taking the speaker setting of this unit into consideration, adjustment will be necessary to the mixing level of the main sound with the effect sound on the rear speakers. By this adjustment, the mixing level of the main sound with the effect sound can suit to your listening condition and taste.

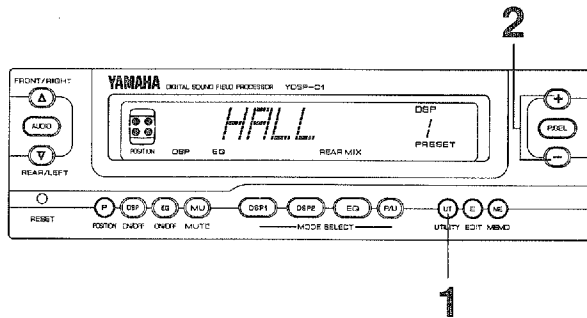

1 Set the display as shown below.

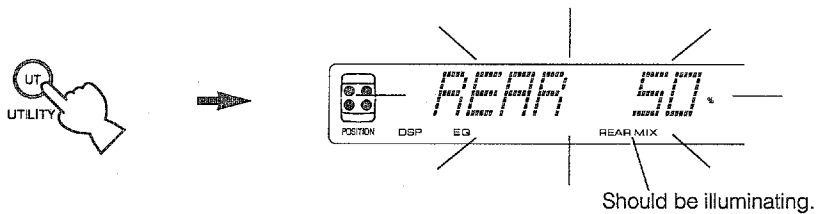

2 Adjust the level value.

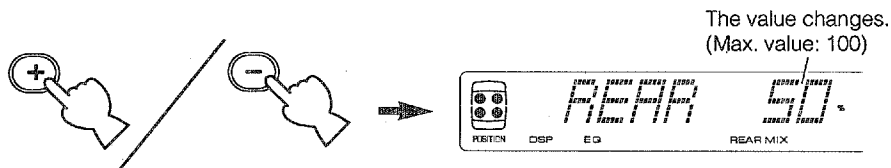

Notes

- After a while, the display before these procedures will be again re-displayed.
- In the step 1, confirm whether the "REAR MIX" indicator is illuminating or not at the bottom of the display. If not, follow the procedures on the next page.
- Note that only the display still shows the level value changes even when this adjustment is not functioning.

To select use of the mixing level adjustor of the main sound on the rear speakers.

If you prefer to use the main sound mixing level adjustor on the rear speakers, check the procedures shown below are completed. If not, perform these procedures.

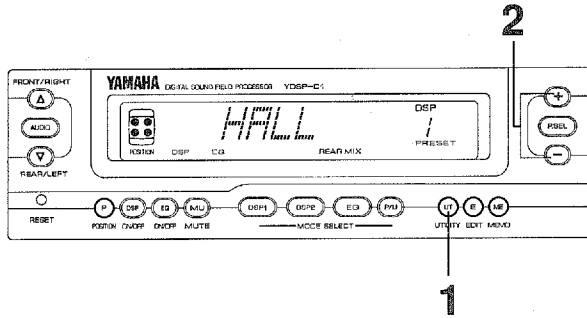

1 Set the display as shown below.

2

Illuminates.
Shows the mixing level adjustment function is ON.

Note
If in the step 1, the "REAR MIX" indicator at the bottom of the display is already illuminating, pressing the + or - button turns off this indicator. In this state, you can not perform the adjustment shown in the previous page.

ADJUSTING THE EFFECT SOUND LEVEL

You can adjust the output level of the effect sound (on activating DSP) at all speakers.

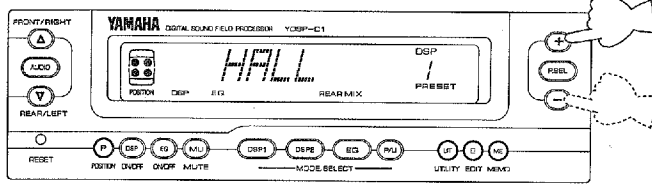

Adjust to the most appropriate level.

To raise the level.

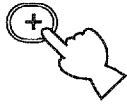

To lower the level.

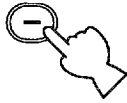

Changes.
(Changeable range: 0-100)
(Preset value: 50)



Note

You cannot adjust the output level of the effect sound while the display shows the mode for adjusting the DSP (or EQ) parameters. (Refer to the pages 32 and 36.)

MUTING SOUND OUTPUT

You can attenuate the sound output level at all speakers by 20dB when you are in a situation that its level needs to be low for a moment.

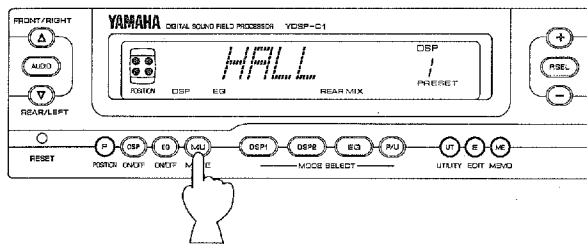

Muting on

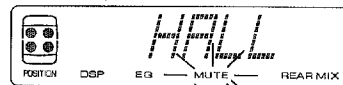

Flashes on and off continuously.

Muting off

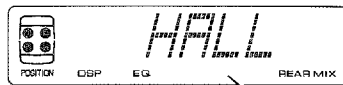

Disappears.

TO DELETE ALL DATA YOU INPUT OR ESCAPE THE "HELP!" MESSAGE

This procedure is necessary in the cases shown below.

- A) When trying to delete all data you input.
- B) When escaping the "HELP!" message.
(Refer to the "TROUBLE SHOOTING". **Note that all data you input will be deleted.**)

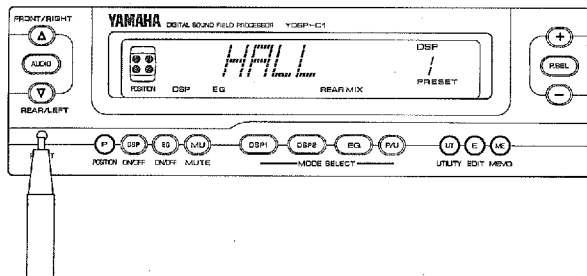

Press and hold by using the point of a mechanical pencil, etc..

SELECTING DSP/EQ PROGRAMS

This unit has 8 preset programs for digital sound field processing (DSP) from actual acoustic environments from around the world, and 4 preset programs for graphic equalizer (EQ). You are allowed to select one of them which match the music you are listening to. All programs consist of some parameters that can be adjusted to provide an even wider range of sounds.

This unit also has 12 user programmable areas where you can store some DSP or EQ programs of your own editing, 8 areas for digital sound field processing and 4 for graphic equalizer. Refer to other sections for detailed information about editing your own programs.

SELECTING PRESET/USER PROGRAMS

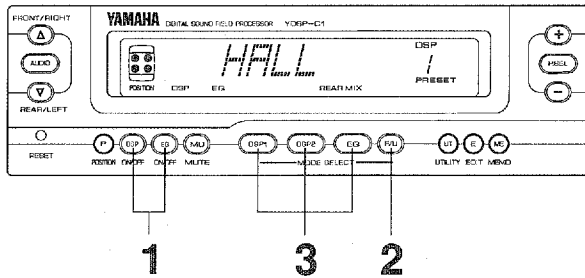

1 Set on the digital sound field processor (DSP) and/or the graphic equalizer (EQ).

* If "DSP" (or "EQ") has already illuminated, you do not have to press the button.

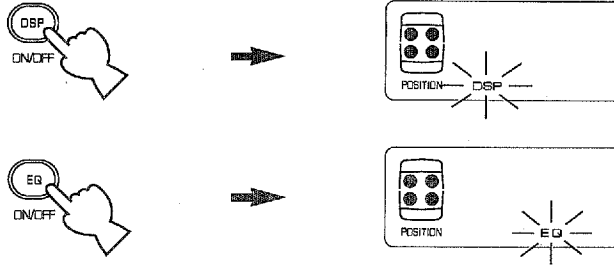

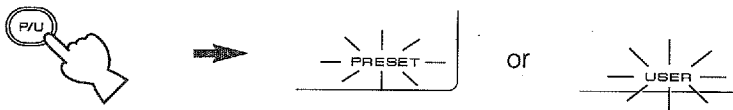

2 Select either the PRESET mode or USER preset mode.



PRESET: Preset programs can be selected in this mode.

USER: User preset programs (or blank areas to be programmed) can be selected in this mode.

- 3** Select a desired program by pressing the **DSP1** or **DSP2** button for DSP programs, and the **EQ** button for EQ programs.
Each button will select one of four programs in turn whenever it is pressed.

	In the PRESET mode	In the USER preset mode
	<pre> 1 HALL ↓ 2 CHAMBER ↓ 3 CHURCH ↓ 4 STADIUM </pre>	<pre> USER1 ↓ USER2 ↓ USER3 ↓ USER4 </pre>
	<pre> 5 JAZZ CLUB ↓ 6 ROCK CON ↓ 7 DISCO ↓ 8 THEATER </pre>	<pre> USER5 ↓ USER6 ↓ USER7 ↓ USER8 </pre>
	<pre> 1 POPS ↓ 2 VOCAL ↓ 3 CLASSIC ↓ 4 FLAT </pre>	<pre> USER1 ↓ USER2 ↓ USER3 ↓ USER4 </pre>

Notes

- A DSP program and an EQ program can be selected together.
To do so, first select a DSP program, and next select an EQ program. If the order of selection is reversed, only a DSP program is selected.
Also, you cannot select a preset program and a user preset program together.
- When you do not need any DSP (or EQ) effect, press the **DSP** (or **EQ**) button so that "DSP" (or "EQ") disappears from the display.

Display information

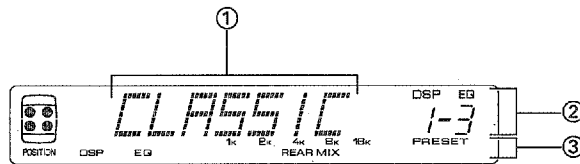

- ① Shows the name of selected program.
- ② Shows the corresponding number(s) of selected program(s).
- ③ Shows whether the unit is in the PRESET mode or the USER preset mode.

DESCRIPTIONS OF PRESET PROGRAMS

SOUND FIELD PROGRAMS

The following list gives brief descriptions of the sound fields produced by each of the DSP programs. Keep in mind that most of these are precise digital recreations of actual acoustic environments, and furthermore, they are adjusted for car audio use. The data for them was recorded at the locations described using sophisticated Yamaha digital sound field data acquisition equipment.

Note

The preset values change according as the selected vehicle interior type. (Refer to page 16.)

1. HALL	<p>This is a fairly common type of concert hall in Europe. It has approximately 2500 seats and features a very beautiful (and acoustically active) wood-panel interior. The overall sound is rich but reserved.</p> <p>Preset Parameter</p> <table border="1" style="width: 100%; border-collapse: collapse; margin-top: 10px;"> <thead> <tr> <th style="width: 20%;"></th> <th style="width: 20%;">TYPE A</th> <th style="width: 20%;">TYPE B</th> <th style="width: 20%;">TYPE C</th> </tr> </thead> <tbody> <tr> <td>IN-DLY</td> <td>50ms</td> <td>45ms</td> <td>45ms</td> </tr> <tr> <td>REV-TIME</td> <td>2.2s</td> <td>1.8s</td> <td>1.8s</td> </tr> <tr> <td>HIGH</td> <td>0.9</td> <td>0.7</td> <td>0.7</td> </tr> </tbody> </table>		TYPE A	TYPE B	TYPE C	IN-DLY	50ms	45ms	45ms	REV-TIME	2.2s	1.8s	1.8s	HIGH	0.9	0.7	0.7
	TYPE A	TYPE B	TYPE C														
IN-DLY	50ms	45ms	45ms														
REV-TIME	2.2s	1.8s	1.8s														
HIGH	0.9	0.7	0.7														
2. CHAMBER	<p>This is the "chamber" that goes with "chamber music." It is a large regularly-shaped room with a high ceiling. A perfect environment for small renaissance and classical ensembles.</p> <p>Preset Parameter</p> <table border="1" style="width: 100%; border-collapse: collapse; margin-top: 10px;"> <thead> <tr> <th style="width: 20%;"></th> <th style="width: 20%;">TYPE A</th> <th style="width: 20%;">TYPE B</th> <th style="width: 20%;">TYPE C</th> </tr> </thead> <tbody> <tr> <td>IN-DLY</td> <td>33ms</td> <td>33ms</td> <td>33ms</td> </tr> <tr> <td>REV-TIME</td> <td>1.8s</td> <td>1.6s</td> <td>1.6s</td> </tr> <tr> <td>HIGH</td> <td>1.0</td> <td>1.0</td> <td>1.0</td> </tr> </tbody> </table>		TYPE A	TYPE B	TYPE C	IN-DLY	33ms	33ms	33ms	REV-TIME	1.8s	1.6s	1.6s	HIGH	1.0	1.0	1.0
	TYPE A	TYPE B	TYPE C														
IN-DLY	33ms	33ms	33ms														
REV-TIME	1.8s	1.6s	1.6s														
HIGH	1.0	1.0	1.0														
3. CHURCH	<p>This program recreates the acoustic environment of a modern church with a high pointed dome and columns along the sides. This interior produces a very few primary reflections.</p> <p>Preset Parameter</p> <table border="1" style="width: 100%; border-collapse: collapse; margin-top: 10px;"> <thead> <tr> <th style="width: 20%;"></th> <th style="width: 20%;">TYPE A</th> <th style="width: 20%;">TYPE B</th> <th style="width: 20%;">TYPE C</th> </tr> </thead> <tbody> <tr> <td>IN-DLY</td> <td>55ms</td> <td>55ms</td> <td>55ms</td> </tr> <tr> <td>REV-TIME</td> <td>2.8s</td> <td>2.8s</td> <td>2.8s</td> </tr> <tr> <td>HIGH</td> <td>0.8</td> <td>0.9</td> <td>0.9</td> </tr> </tbody> </table>		TYPE A	TYPE B	TYPE C	IN-DLY	55ms	55ms	55ms	REV-TIME	2.8s	2.8s	2.8s	HIGH	0.8	0.9	0.9
	TYPE A	TYPE B	TYPE C														
IN-DLY	55ms	55ms	55ms														
REV-TIME	2.8s	2.8s	2.8s														
HIGH	0.8	0.9	0.9														

<p>4. STADIUM</p>	<p>This program gives you the long delays and extraordinarily spacious feel of a stadium that is no less than 300 meters (990 feet) in diameter.</p> <p>Preset Parameter</p> <table border="1"> <thead> <tr> <th></th> <th>TYPE A</th> <th>TYPE B</th> <th>TYPE C</th> </tr> </thead> <tbody> <tr> <td>IN-DLY</td> <td>55ms</td> <td>58ms</td> <td>55ms</td> </tr> <tr> <td>R-TIME</td> <td>2.2</td> <td>2.3</td> <td>2.3</td> </tr> <tr> <td>LIVE</td> <td>5</td> <td>8</td> <td>7</td> </tr> </tbody> </table>		TYPE A	TYPE B	TYPE C	IN-DLY	55ms	58ms	55ms	R-TIME	2.2	2.3	2.3	LIVE	5	8	7
	TYPE A	TYPE B	TYPE C														
IN-DLY	55ms	58ms	55ms														
R-TIME	2.2	2.3	2.3														
LIVE	5	8	7														
<p>5. JAZZ CLUB</p>	<p>A traditional New York jazz club. This room has a low ceiling, and the "stage" is located in a corner. This program does not produce nearly as many reflections as the HALL or CHURCH programs, but creates an intimate "close-to-the-music" feel.</p> <p>Preset Parameter</p> <table border="1"> <thead> <tr> <th></th> <th>TYPE A</th> <th>TYPE B</th> <th>TYPE C</th> </tr> </thead> <tbody> <tr> <td>IN-DLY</td> <td>20ms</td> <td>8ms</td> <td>14ms</td> </tr> <tr> <td>R-SIZE</td> <td>1.0</td> <td>1.2</td> <td>1.1</td> </tr> <tr> <td>LIVE</td> <td>3</td> <td>4</td> <td>4</td> </tr> </tbody> </table>		TYPE A	TYPE B	TYPE C	IN-DLY	20ms	8ms	14ms	R-SIZE	1.0	1.2	1.1	LIVE	3	4	4
	TYPE A	TYPE B	TYPE C														
IN-DLY	20ms	8ms	14ms														
R-SIZE	1.0	1.2	1.1														
LIVE	3	4	4														
<p>6. ROCK CONCERT</p>	<p>The ideal program for lively, dynamic rock music. The data for this program was recorded at LA's "hottest" rock live spot.</p> <p>Preset Parameter</p> <table border="1"> <thead> <tr> <th></th> <th>TYPE A</th> <th>TYPE B</th> <th>TYPE C</th> </tr> </thead> <tbody> <tr> <td>IN-DLY</td> <td>35ms</td> <td>33ms</td> <td>30ms</td> </tr> <tr> <td>R-SIZE</td> <td>1.2</td> <td>1.2</td> <td>1.4</td> </tr> <tr> <td>LIVE</td> <td>5</td> <td>6</td> <td>6</td> </tr> </tbody> </table>		TYPE A	TYPE B	TYPE C	IN-DLY	35ms	33ms	30ms	R-SIZE	1.2	1.2	1.4	LIVE	5	6	6
	TYPE A	TYPE B	TYPE C														
IN-DLY	35ms	33ms	30ms														
R-SIZE	1.2	1.2	1.4														
LIVE	5	6	6														
<p>7. DISCO</p>	<p>Discos tend to have a high-energy, "immediate" sound. This one is no exception. The room itself is circular, approximately 20 meters (65 feet) in diameter.</p> <p>Preset Parameter</p> <table border="1"> <thead> <tr> <th></th> <th>TYPE A</th> <th>TYPE B</th> <th>TYPE C</th> </tr> </thead> <tbody> <tr> <td>IN-DLY</td> <td>10ms</td> <td>10ms</td> <td>12ms</td> </tr> <tr> <td>R-SIZE</td> <td>1.0</td> <td>1.3</td> <td>1.0</td> </tr> <tr> <td>LIVE</td> <td>9</td> <td>7</td> <td>8</td> </tr> </tbody> </table>		TYPE A	TYPE B	TYPE C	IN-DLY	10ms	10ms	12ms	R-SIZE	1.0	1.3	1.0	LIVE	9	7	8
	TYPE A	TYPE B	TYPE C														
IN-DLY	10ms	10ms	12ms														
R-SIZE	1.0	1.3	1.0														
LIVE	9	7	8														
<p>8. THEATER</p>	<p>By providing clean projection of music and dialogue, this program produces an excellent acoustic environment for the theater. For example, this program is more effective if used in a drive-in theater.</p> <p>Preset Parameter</p> <table border="1"> <thead> <tr> <th></th> <th>TYPE A</th> <th>TYPE B</th> <th>TYPE C</th> </tr> </thead> <tbody> <tr> <td>IN-DLY</td> <td>20ms</td> <td>20ms</td> <td>20ms</td> </tr> <tr> <td>R-SIZE</td> <td>1.2</td> <td>1.2</td> <td>1.2</td> </tr> <tr> <td>LIVE</td> <td>5</td> <td>5</td> <td>5</td> </tr> </tbody> </table>		TYPE A	TYPE B	TYPE C	IN-DLY	20ms	20ms	20ms	R-SIZE	1.2	1.2	1.2	LIVE	5	5	5
	TYPE A	TYPE B	TYPE C														
IN-DLY	20ms	20ms	20ms														
R-SIZE	1.2	1.2	1.2														
LIVE	5	5	5														

GRAPHIC EQUALIZER PROGRAMS

The following list gives brief descriptions of preset graphic equalizer programs. You can select one of four programs to match the tonal response to the type of music you are listening to.

1. POPS	Low range and high range of the source sound are somewhat emphasized. It is suitable for listening to pop or rock music.
2. VOCAL	Vocal part of the source sound is emphasized.
3. CLASSIC	More expanded sound is gained. It is suitable for listening to classic music, etc.
4. FLAT	The source sound is played back without any particular sound-processing.

CREATING YOUR OWN SOUND FIELDS

WHAT IS A SOUND FIELD?

In order to explain the impressive functions of the DSP system, let's go where it all begins, and find out what a sound field really is.

What really creates the rich, full tones of a live instrument are the multiple reflections from the walls of the room. In addition to making the sound "live", these reflections enable us to tell where the player is situated, and the size and shape of the room in which we are sitting. We can even tell whether it is highly reflective, with steel and glass surfaces, or more absorbent—wood panels, carpeting and curtains.

THE ELEMENTS OF A SOUND FIELD

In any environment, in addition to the direct sound coming straight to our ears from the player's instrument, there are two distinct types of sound reflections that combine to make up the sound field.

- (1) Early Reflections (**ER-type**). Reflected sounds that reach our ears extremely rapidly (50 ms – 100 ms after the direct sound), after reflecting from one surface only—for example, from the ceiling or one wall. These reflections fall into specific patterns as shown in the diagram on pages 33-35 for any particular environment, and provide vital information to our ears. Early reflections actually add clarity to the sound.
- (2) Subsequent Reverberations (**REV-type**). These are caused by reflections from more than one surface—walls, ceiling, the back of the room—so numerous that they merge together to form a continuous sonic "afterglow". They are non-directional, and lessen the clarity of any sound.

Direct sound, early reflections and subsequent reverberations taken together indicate to us very clearly the subjective size and shape of the room, and it is this information that the DSP system reproduces in order to create sound fields.

If you could only create the appropriate early reflections and subsequent reverberations in your car room, you would be able to create your own listening environment. The acoustics in your car room could be changed to those of a concert hall, a dance floor, or virtually any size room at all. This ability to create sound fields at will is exactly what Yamaha has done with the DSP system.

In addition to allowing you to recreate the sound fields of famous listening environments from around the world, the DSP system allows you to create your own sound fields. Starting with one of the built-in programs, you can adjust such parameters as apparent room size, reverberation time, and distance from you to the performer.

SELECTING AND EDITING PROGRAM PARAMETERS

* Never perform these operations while driving.

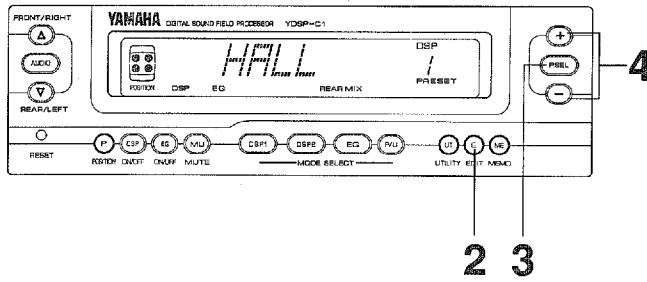

1 Select a preset program by following the procedure on page 26 and 27.

2 Set the display as shown below.

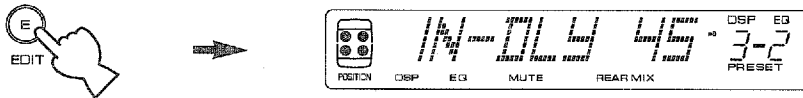

3 Select any parameter.

* One of three parameters is selected in turn whenever the **P.SEL** button is pressed.



ER-type

REV-type

IN-DLY (Initial Delay)
↓
R-SIZE (Room Size)
↓
LIVE (Liveness)

IN-DLY (Initial Delay)
↓
REV-TIME (Reverberation Time)
↓
HIGH (High Frequency Reverberation Time Ratio)

- Programs of **ER-type** STADIUM/JAZZ CLUB/ROCK CON/DISCO/THEATER
- Programs of **REV-type** HALL/CHAMBER/CHURCH

4 Increase or decrease the value of the selected parameters.

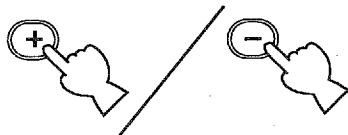

5 In the same way, edit other parameters.

Notes

- Each DSP preset program has a preset equalizer mode.
To edit parameters of the equalizer mode, follow the steps on page 36.
- Parameter edits made in this way will remain until it is switched to a different program.
- The original display mode is resumed 30 seconds after the above operations.

DESCRIPTIONS OF THE DIGITAL SOUND FIELD PARAMETERS

Not all of the following parameters are found in every program. Refer to the "DSP PROGRAM PARAMETER TABLE" on pages 39-41 for a complete list of the parameters in each program.

● **IN-DLY (Initial Delay)**

How it Affects the Sound:

Changes the apparent distance from the source sound.

Since the distance from the sound source from a reflective surface determines the delay between the direct sound and the first reflection, this parameter changes the location of the sound source within the acoustic environment.

What it Does:

Adjusts the delay between the direct sound and the first reflection heard by the listener.

Control Range:

1 – 100 milliseconds

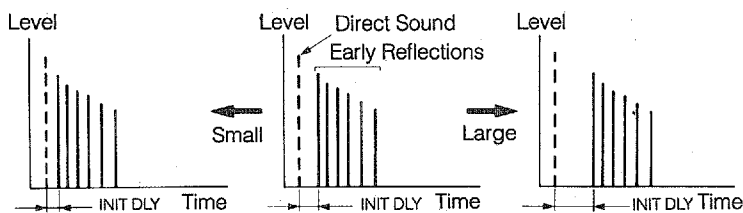

● R-SIZE (Room Size)

How it Affects the Sound:

Changes the apparent size of the listening space. The larger the value, the larger the simulated listening space will sound.

What it Does:

Adjusts the timing between the early reflections. Early reflections are the first group of reflections you hear before the subsequent, dense reverberation begins.

Control Range:

0.1 – 4.0

Changing this parameter from 1 to 2 increases the apparent volume of the listening space eight times (length, width, and height all doubled).

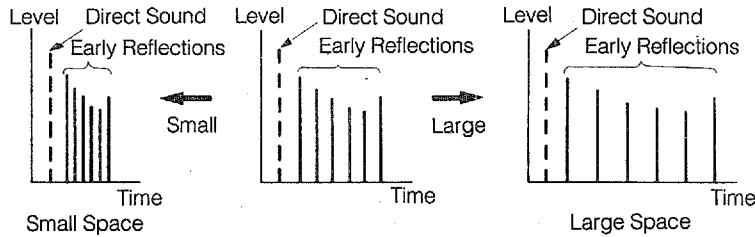

● LIVE (Liveness)

How it Affects the Sound:

This parameter changes the apparent reflectivity of the walls in the hall.

The early reflections from a sound source will lose intensity (decay) much faster in a listening space with acoustically absorbent inner surfaces than in one which has mostly reflective surfaces. A listening space with highly reflective surfaces in which the early reflections decay slowly is termed "live", while a listening space with absorbent characteristics in which the reflections decay rapidly is termed "dead". The LIVE parameter lets you adjust the early reflection decay rate, and thus the "liveness" of the listening space.

What it Does:

Changes the rate at which the early reflections decay.

Control Range:

0 – 10.

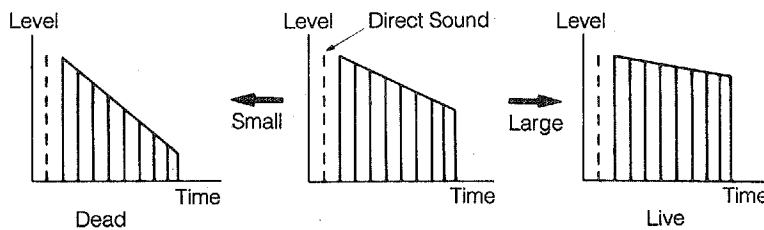

● REV-TIME (Reverberation Time)

How it Affects the Sound:

The natural reverberation time of a listening space depends primarily on its size and the characteristics of its inner surfaces. This parameter, therefore, changes the apparent size of the acoustic environment over an extremely wide range.

What it Does:

Adjusts the amount of time it takes for the level of the dense, subsequent reverberation sound to decay by 60dB (@ 1 kHz).

Control Range:

0.3 – 10.0 seconds.

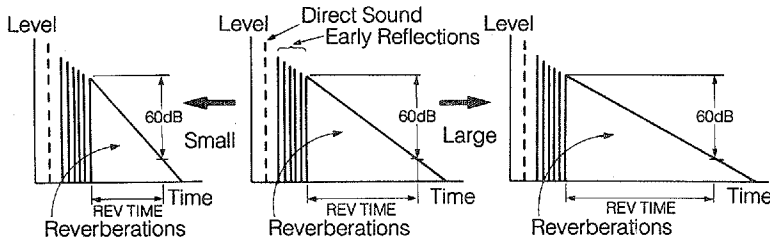

● HIGH (High Frequency Reverberation Time Ratio)

How it Affects the Sound:

Because of dissipation in the air, and depending on the characteristics of the listening space's inner surfaces, the high frequency reverberation in a real acoustic environment generally decays quicker than the low frequency reverberation. The HIGH parameter accurately simulates this effect. A HIGH setting of 0.5, for example, results in high frequency reverberation time only one-half as long as the low-frequency reverberation.

What it Does:

Changes the reverberation time of the high frequencies in relation to the lower frequencies.

Control Range:

0.1 – 1.0

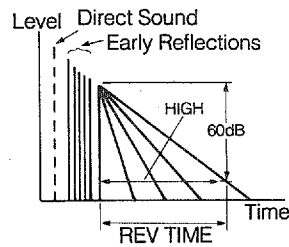

ADJUSTING EQUALIZER PARAMETERS

The built-in graphic equalizer consists of nine frequency bands. You are allowed to adjust the tonal balance of each EQ preset program at will by separately attenuating or emphasizing nine distinct frequency bands (63, 125, 250, 500, 1k, 2k, 4k, 8k and 16 kHz). Each band is adjustable within a range of -12dB to +12dB. Setting to a higher value emphasizes, and setting to a lower value attenuates the frequency response.

* Never perform these operations while driving.

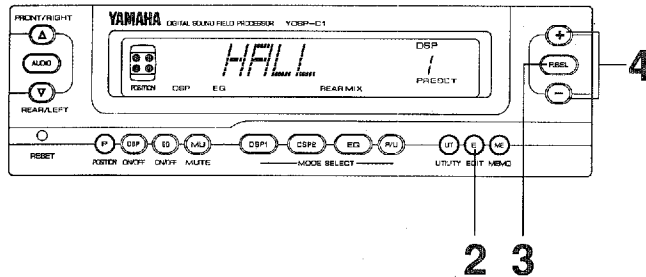

1 Select a preset program by following the procedure on pages 26 and 27.

2 Set the display as shown below.

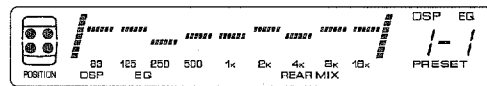

3 Select a frequency band

* One of nine bands is selected in turn whenever the **P.SEL** button is pressed.

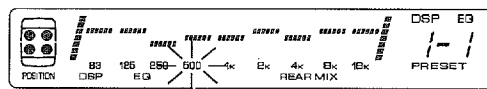

The selected frequency flashes on and off.

4 Adjust the value.

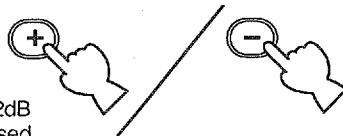

* The value will change by 2dB everytime a button is pressed.

5 In the same way, adjust the value for other bands.

Notes

- In step 4, in the display, the bar indicator above the selected frequency band will flash when it is set to the center (0dB) position.
- Adjustments made in this way will remain until it is switched to a different program.
- The original display mode is resumed 30 seconds after the above operations.

STORING AN EDITED PROGRAM IN THE USER MEMORY

Once you've edited the parameters of one of the DSP/EQ preset programs and created the sound you want, you can store your original program into one of this unit's 12 user programmable areas (8 for DSP and 4 for EQ) so you can recall it again later without having to re-edit all the parameters individually.

*** Never perform these operations while driving.**

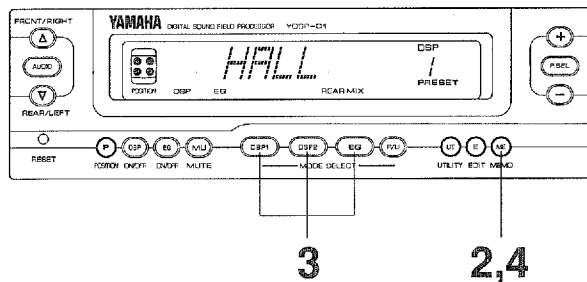

1 Edit your original program following the procedures on page 32 or 36. After you've finished editing, do not switch to a different program.

2

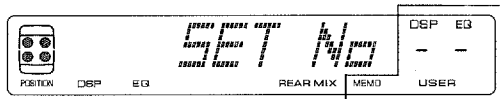

Flashes.

* Follow the next step while the display is flashing. Otherwise, after a few seconds, the display will return to the previous mode.

3

Select a user programmable area which you wish to store the program to by using a corresponding button. (Refer to pages 26 and 27 for the procedure.)

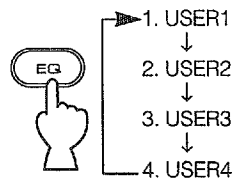
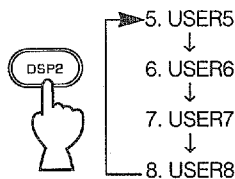
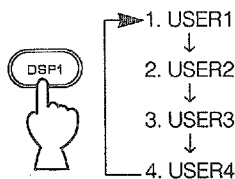

The corresponding number of the selected area is displayed.

4 Shortly press the **ME** button again.



5 In the same way, store more original programs into other areas.

To call your original program stored in the memory

Follow the procedure on pages 26 and 27.

Notes

- In one of the DSP programmable user areas (1-8), a DSP program and a EQ program can be stored as a pair. On the otherhand, in one of the EQ user programmable areas (1-4), only a EQ program can be stored.
- In step 3, if a user programmable area is selected after the display have stopped flashing, all your original parameter data will be erased and you'll have to re-edit the entire program.
If the display stop flashing before you get a chance to select a user programmable area, simply press the **ME** button again.
- If you store a new program to a user programmable area which contains a previous program, the program originally contained in the user programmable area will be erased and replaced with the new data.

Memory back-up

The memory back-up circuit prevents the stored program data from being lost even if the power is cut by the ignition key. If, however, the battery is removed or goes weak or goes flat for more than three days, the memory may be erased. In this case, when the power is supplied again, the display shows "HELP!" for about 10 seconds and this unit is initialized automatically. After then, you can re-store your programs by simply following the above steps.

DSP PROGRAM PARAMETER TABLE

The preset values change according as the selected vehicle interior type. (Refer to page 17.)
• TYPE A

No.	Program Name	Parameter Name	Preset Value		EQ parameter preset value (dB)																
			Minimum	Maximum	63	125	250	500	1k	2k	4k	8k	16k								
1	HALL	IN-DLY	1ms ←	→ 70ms																	
		REV-TIME	0.3s ←	→ 2.2s																	
		HIGH	0.1 ←	→ 0.9																	
2	CHAMBER	IN-DLY	1ms ←	→ 33ms																	
		REV-TIME	0.3s ←	→ 1.8s																	
		HIGH	0.1 ←	→ 1.0																	
3	CHURCH	IN-DLY	1ms ←	→ 55ms																	
		REV-TIME	0.3s ←	→ 2.8s																	
		HIGH	0.1 ←	→ 0.8																	
4	STADIUM	IN-DLY	1ms ←	→ 55ms																	
		R-SIZE	0.1 ←	→ 2.2																	
		LIVE	0 ←	→ 5																	
5	JAZZ CLUB	IN-DLY	1ms ←	→ 20ms																	
		R-SIZE	0.1 ←	→ 1.0																	
		LIVE	0 ←	→ 3																	
6	ROCK CON	IN-DLY	1ms ←	→ 35ms																	
		R-SIZE	0.1 ←	→ 1.2																	
		LIVE	0 ←	→ 5																	
7	DISCO	IN-DLY	1ms ←	→ 10ms																	
		R-SIZE	0.1 ←	→ 1.0																	
		LIVE	0 ←	→ 9																	
8	THEATER	IN-DLY	1ms ←	→ 20ms																	
		R-SIZE	0.1 ←	→ 1.2																	
		LIVE	0 ←	→ 5																	

• TYPE C

No.	Program Name	Parameter Name	Preset Value			EQ parameter preset value (dB)									
			Minimum	Preset Value	Maximum	63	125	250	500	1k	2k	4k	8k	16k	
1	HALL	IN-DLY	1ms	← 45ms	→ 70ms										
		REV-TIME	0.3s	← 1.8s	→ 10.0s	+2	0	0	+2	0	0	0	0	0	+2
		HIGH	0.1	← 0.7	→ 1.0										
2	CHAMBER	IN-DLY	1ms	← 33ms	→ 100ms										
		REV-TIME	0.3s	← 1.6s	→ 10.0s	-2	0	0	0	0	0	-2	0	+4	
		HIGH	0.1	← 1.0											
3	CHURCH	IN-DLY	1ms	← 55ms	→ 100ms										
		REV-TIME	0.3s	← 2.8s	→ 10.0s	-4	-2	0	0	0	0	-2	-4	-8	
		HIGH	0.1	← 0.9	→ 1.0										
4	STADIUM	IN-DLY	1ms	← 55ms	→ 100ms										
		REV-TIME	0.3s	← 2.8s	→ 10.0s	-4	-2	0	0	0	0	-2	-4	-8	
		HIGH	0.1	← 0.9	→ 1.0										
5	JAZZ CLUB	IN-DLY	1ms	← 14ms	→ 100ms										
		REV-TIME	0.1	← 1.1	→ 4.0	+2	+2	+2	0	0	0	0	+4	+6	
		HIGH	0	← 4	→ 10										
6	ROCK CON	IN-DLY	1ms	← 30ms	→ 100ms										
		REV-TIME	0.1	← 1.4	→ 4.0	+2	+2	+2	0	0	0	0	+2	+4	
		HIGH	0	← 6	→ 10										
7	DISCO	IN-DLY	1ms	← 12ms	→ 100ms										
		REV-TIME	0.1	← 1.0	→ 4.0	0	+2	+2	0	0	0	0	+4	+4	
		HIGH	0	← 8	→ 10										
8	THEATER	IN-DLY	1ms	← 20ms	→ 100ms										
		REV-TIME	0.1	← 1.2	→ 4.0	0	+2	0	0	0	0	0	+2	0	
		HIGH	0	← 5	→ 10										

EQ PROGRAM PARAMETER TABLE

• TYPE A

No.	Program Name	EQ parameter preset value (dB)								
		63	125	250	500	1k	2k	4k	8k	16k
1	POPS	+2	0	0	0	+2	0	0	+4	+4
2	VOCAL	0	0	0	+2	+2	+2	0	0	+2
3	CLASSIC	+2	0	0	0	0	0	0	+2	+4
4	FLAT	0	0	0	0	0	0	0	0	0

• TYPE B

No.	Program Name	EQ parameter preset value (dB)								
		63	125	250	500	1k	2k	4k	8k	16k
1	POPS	0	0	0	0	0	+2	0	+2	+4
2	VOCAL	-2	-2	0	+2	+2	+2	0	0	+2
3	CLASSIC	+2	0	0	0	0	0	0	+2	+4
4	FLAT	0	0	0	0	0	0	0	0	0

• TYPE C

No.	Program Name	EQ parameter preset value (dB)								
		63	125	250	500	1k	2k	4k	8k	16k
1	POPS	0	+2	+2	0	0	0	0	+2	+4
2	VOCAL	0	0	+2	+2	+2	+2	0	+2	+4
3	CLASSIC	+4	+2	0	0	0	0	0	0	+4
4	FLAT	0	0	0	0	0	0	0	0	0

DIMENSIONS

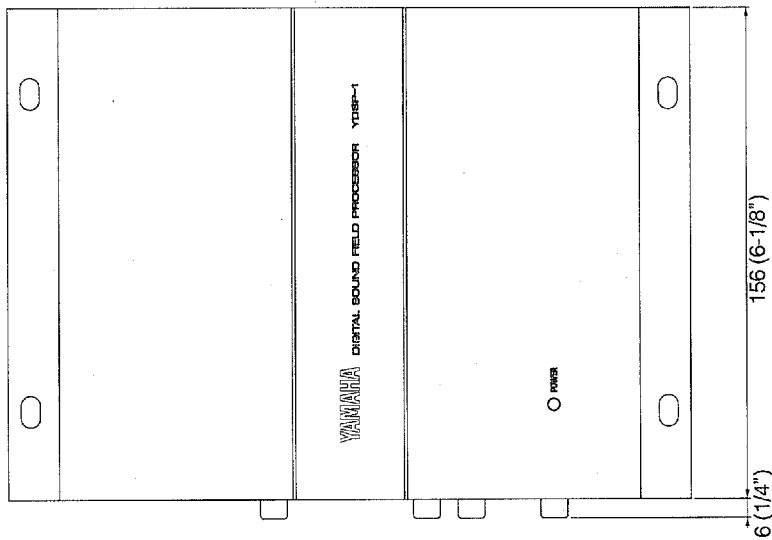
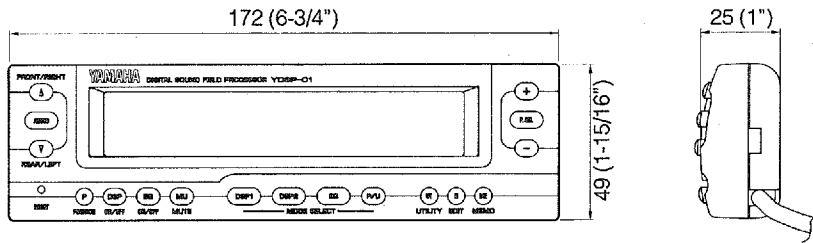

Unit: mm (inch)

TROUBLESHOOTING

PROBLEM	CAUSE	REMEDY
No power.	Fuse blown.	Replace the fuse.
	Improper connection of lead wire.	Connect the leads properly referring to the connection diagram.
No sound.	Bad or incorrect speaker connection. Bad or incorrect input connection.	Check connections.
Left/right channel sound reversed.	Leads have been connected in reverse.	Check colors of leads and connect correctly.
The unit will not work as it is commanded (In this case, "HELP!" appears in the display.)	Built-in microprocessor is not functioning.	Stop the car first. Cut the power supply to this unit and then supply it again by switching the ignition key. If this step is of no effect, press the RESET button. (However, this operation will erase all data you stored.) If both the steps are of no effect, contact your Yamaha dealer.
"HELP!" appears in the display when power is supplied after the battery is replaced, the battery goes flat, etc.	It shows that the data you stored have been all erased.	This unit will be initialized automatically.

SPECIFICATIONS

Output Level/Impedance.....	1.5 V/560 Ω
Input Sensitivity/Impedance.....	1.5 V/20 kΩ
Frequency Response.....	20 Hz – 20 kHz
Total Harmonic Distortion (20 Hz – 20 kHz)	
Output Level 1.5 V, 20 kHz LOW PASS FILTER.....	Less than 0.03%
Signal-to-Noise Ratio (IHF-A Network).....	More than 90 dB
Equalizer Band.....	9-band
Center Frequency.....	63, 125, 250, 500, 1k, 2k, 4k, 8k, 16 kHz
Boost/Attenuation.....	± 12 dB (2 dB per a step)
Subwoofer Frequency (THROUGH, 130 Hz, 80 Hz).....	-6 dB/oct.
Audio Muting.....	-20 dB
DSP Preset Programs.....	8 (HALL, CHAMBER, CHURCH, STADIUM, JAZZ CLUB, ROCK CON, DISCO, THEATER)
DSP User Programmable Areas.....	8
EQ Preset Programs.....	4 (POPS, VOCAL, CLASSIC, FLAT)
EQ User Programmable Areas.....	4
Power Supply.....	14.4 V
Power Consumption.....	800 mA (Less than 1 mA for memory back up)
Dimensions (W × H × D)	
Main Unit.....	215 × 52.5 × 162 mm (8-7/16" × 2-1/16" × 6-5/16")
Commander Unit.....	172 × 25 × 49 mm (6-3/4" × 1-1/16" × 1-15/16")
Weight	
Main Unit.....	1.5 kg (3 lbs. 5 oz.)
Commander Unit.....	0.2 kg (7 oz.)
Accessories.....	Commander unit
	4.5 m extension cable
	Power cords
	Frame
	Mounting hardware
	Magic fastener x2
	5x16 tapping hex screw with washer x4
	M2x5 screw x4
	M5x8 screw x4
	M5x8 hex screw with washer x4

* Specifications are subject to change without notice.

YAMAHA

YAMAHA ELECTRONICS CORPORATION, USA 6722 ORANGETHORPE AVE., BUENA PARK, CALIF. 90620, U.S.A.
YAMAHA CANADA MUSIC LTD. 135 MILNER AVE., SCARBOROUGH, ONTARIO M1S 3R1, CANADA
YAMAHA ELECTRONIK EUROPA G.m.b.H. SIEMENSSTR. 22-34, D-2084 RELLINGEN, BEI HAMBURG, F.R. OF GERMANY
YAMAHA ELECTRONIQUE FRANCE S.A. 17 RUE DES CAMPANULES, LOGNES 77321 MARNE LA VALLEE CEDEX 2 FRANCE
YAMAHA ELECTRONICS (UK) LTD. YAMAHA HOUSE, 200 RICKMANSWORTH ROAD WATFORD, HERTS WD1 7JS, ENGLAND
YAMAHA SCANDINAVIA A.B. J A WETTERGRENS GATA 1, BOX 30053, 400 43 VASTRA FRÖLUNDA, SWEDEN
YAMAHA MUSIC AUSTRALIA PTY, LTD. 17-33 MARKET ST., SOUTH MELBOURNE, 3205 VIC., AUSTRALIA

VK99840 BWB, O Printed in Japan  